

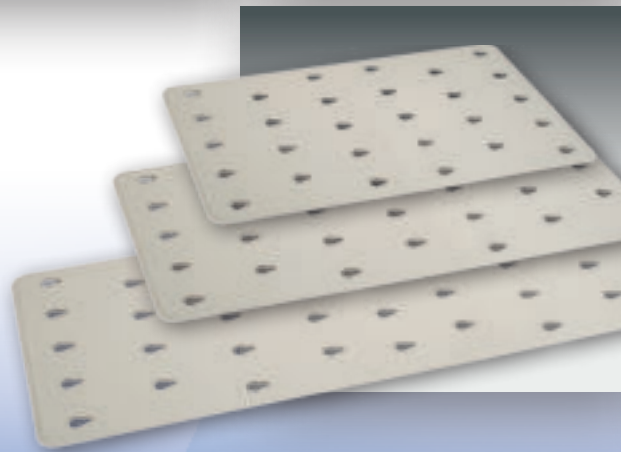

HOME line

2024



*Soluciones para el Hogar*  
*Solutions pour la maison*  
*Home Solutions*



# NEW

## Nuevas Incorporaciones Nouveautés - New Products

### Separador huevo

Pg. 6  
Séparateur d'oeufs  
Egg Separator



### Rallador queso lama acero inox y tapa

Pg. 6  
Râpe à fromage lame en  
acier inox avec couvercle  
Cheese grater  
stainless blade with lid



### Cuencos Pasteleros con base antideslizante

Pg. 7  
Bols Patissier antidérapant  
Cake mixing Bowls  
with non-slip ring



### Libradores fondo plano (mango ergonómico y bordes suavizados)

Pg. 13  
Pelles à farine fond plat  
(poignée ergonomique et bords lissés)  
Flat bottom Scoops  
(ergonomic handle and smoothed edges)



### Plato Patatas Fritas 4 salsas "Nogal"

Pg. 21  
Plat a frites  
4 sauces "Noyer"  
French fries dish  
4 sauces "Walnut"



### Cubetas modulares transparentes

Pg. 31  
Bacs  
modulaires  
transparentes  
Transparent  
modular boxes



### Cesta Compra

Pgs. 33 - 58  
Pannier a distribution  
Shopping basket



### Cubeta Reciclar Orgánico "Marrón"

Pgs. 40 - 41  
Poubelle recyclage Organique "Brun"  
Organic Recycling bin "Brown"



### Papelera Basculante "Media Luna"

Pg. 44  
Poubelle inclinable  
"Demi-Lune"  
"Half Moon"  
Tilting Trash Can



### Desatascador

Pg. 48  
Débouchoir  
Plunger

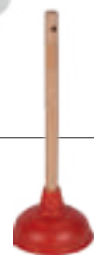

Todos los artículos FERVIK, están fabricados con materiales aptos para el contacto con los alimentos de conformidad con las últimas disposiciones de la ley. FERVIK, S.A. dispone del Registro Sanitario N° 39-03319/B  
Toutes les articles FERVIK, ils sont fabriqués avec des matériaux aptes pour le contact avec les aliments de conformité aux dernières dispositions de la loi. FERVIK, S.A. dispose de Registre Sanitaire N° 39-03319/B  
All the FERVIK items are made of materials suitable to get in food contact as per new law disposals. FERVIK, S.A. have an European Health Food register N° 39-03319/B

Alimentación · Alimentation · Feeding

Págs. 4 - 26

 Pág. 4	 Pág. 4	 Pág. 5	 Pág. 5	 Pág. 6	 Pág. 6	 Pág. 6
 Pág. 7	 Pág. 7	 Pág. 8	 Pág. 8	 Pág. 8	 Pág. 9	 Pág. 9
 Pág. 9	 Pág. 10	 Pág. 10	 Pág. 10	 Pág. 11	 Pág. 11	 Pág. 11
 Pág. 12	 Pág. 12	 Pág. 13	 Pág. 13	 Pág. 14	 Pág. 14	 Pág. 15
 Pág. 15	 Pág. 16	 Pág. 16	 Pág. 16	 Pág. 17	 Págs. 18 - 19	 Pág. 20
 Pág. 20	 Pág. 21	 Pág. 21	 Pág. 22	 Pág. 23	 Pág. 23	 Pág. 23
 Pág. 24	 Pág. 24	 Pág. 25	 Pág. 25	 Pág. 26	 Pág. 26	

Menaje · Ware · Household

Págs. 27 - 29

 Pág. 27	 Pág. 27	 Pág. 27	 Pág. 28	 Pág. 28
 Pág. 28	 Pág. 29	 Pág. 29	 Pág. 29	



COCINA / COMEDOR

CUISINE / SALLE À MANGER  
KITCHEN / DINING ROOM



### Espátulas PA-220

Spatules  
Spatula

Ref.	Tamaño Cms.
<b>361</b>	<b>25 x 5</b>
<b>362</b>	<b>30 x 6</b>
<b>363</b>	<b>35 x 7</b>
<b>364</b>	<b>40 x 8</b>
<b>365</b>	<b>50 x 9</b>

### Cuchara PA-220

Couillère  
Spoon

Ref.	Tamaño Cms.
<b>368</b>	<b>30</b>



### Tapa-plato Microondas

Cloche a micro-ondes  
Microwave cover



Ref.	Ø x Altura Cms.
<b>623</b>	<b>23 x 6</b>
<b>626</b>	<b>26 x 6,5</b>





## Bols Polipropileno

Bols PP  
Bowls PP



Ref.	Capacidad Lts.	Ø x Altura Cms.
<b>3323</b>	<b>0,4</b>	<b>13 x 6</b>
<b>3324</b>	<b>1</b>	<b>17 x 8</b>
<b>3325</b>	<b>3</b>	<b>24 x 11</b>
<b>3326</b>	<b>5</b>	<b>28 x 14</b>
<b>3327</b>	<b>7</b>	<b>33 x 16</b>
<b>3328</b>	<b>11</b>	<b>38 x 18</b>



## Cuencos

Bols  
Bowls



Ref.	Capacidad Lts.	Ø x Altura Cms.
<b>779</b>	<b>0,6</b>	<b>14 x 5</b>
<b>780</b>	<b>1,5</b>	<b>19 x 7</b>
<b>781</b>	<b>3</b>	<b>24 x 9</b>

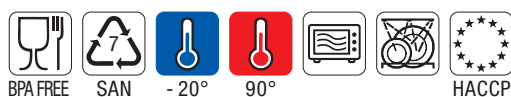



## Set 3 Bols Pasteleros con base antideslizante

Set 3 Bols pâtissier antidérapant  
3 Cake Bowls set with  
non-slip ring



Ref.	Capacidad Lts.	Ø x Altura Cms.
	<b>1,5</b>	<b>17 x 12</b>
<b>1169</b>	<b>2</b>	<b>19 x 12</b>
	<b>3</b>	<b>22 x 12</b>



## Separador huevo

Séparateur d'oeufs  
Egg Separator



Ref.	Tamaño Cms.
<b>1232</b>	<b>Ø 6,5 x 12,5 x 2,5</b>



## Rallador queso lama acero inox y tapa

Râpe à fromage lame en  
acier inox avec couvercle

Cheese grater  
stainless blade with lid



Ref.	Tamaño Cms.
<b>1148</b>	<b>17 x 8 x 7</b>



## Cuencos Pasteleros con base antideslizante

*Bols Pâtissier antidérapant*  
*Cake mixing Bowls with non-slip ring*



## Set 2 Cuencos + Separador Huevo

*Set 2 Bols + Séparateur d'Oeufs*  
*Set 2 Bowls + Egg Separator*



Ref.	Capacidad Lts.	Ø x Altura Cms.
<b>1141</b>	<b>1,5</b>	<b>16 x 13</b>
<b>1143</b>	<b>3</b>	<b>20 x 13</b>
<b>1140</b>	<b>1,5 + 3 + Separador</b>	<b>1232</b>

## Bols Acrílicos

*Bols Acryliques*  
*Acrylic Bowls*



Ref.	Capacidad Lts.	Ø x Altura Cms.
<b>3333</b>	<b>0,4</b>	<b>13 x 6</b>
<b>3334</b>	<b>1</b>	<b>17 x 8</b>
<b>3335</b>	<b>3</b>	<b>24 x 11</b>
<b>3336</b>	<b>5</b>	<b>28 x 14</b>
<b>3337</b>	<b>7</b>	<b>33 x 16</b>
<b>3338</b>	<b>11</b>	<b>38 x 18</b>

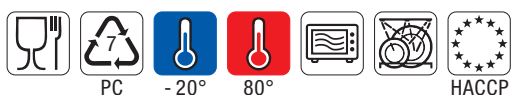





## Colador esférico

*Crépine sphérique*  
*Spherical strainer*



Ref.	Ø x Altura Cms.
<b>1186</b>	<b>8 x 18</b>
<b>1187</b>	<b>10 x 22,5</b>
<b>1188</b>	<b>12 x 27</b>
<b>1189</b>	<b>14 x 30</b>

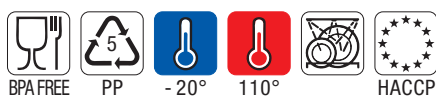

## Vaso Medidor 0,5 L.

*Verre doseur*  
*Measuring tumbler*



Ref.	Ø x Altura Cms.
<b>824</b>	<b>9 x 16</b>

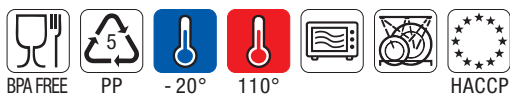

## Jarra Medidora 1,5 L.

*Pichet doseur 1,5 L.*  
*Measuring Jug 1,5 L.*



Ref.	Ø x Altura Cms.
<b>816</b>	<b>12 x 19</b>



## Multiescurridor Descongelación

Multi-égouttoir  
Multidrainer



Ref.	Tamaño Cms.
<b>823</b>	<b>31 x 20 x 5</b>



## Rejillas para Cubetas

Grilles à bacs  
Grilles for butchers



Ref.	Capacidad Lts.	Tamaño Cms.
<b>934</b>	<b>4, 12 y 21</b>	<b>19 x 26 x 1,5</b>
<b>936</b>	<b>6 y 17</b>	<b>22 x 32 x 1,5</b>

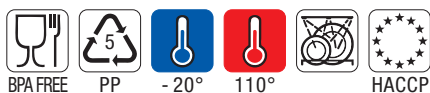

## Escurreverduras

Passoire  
Colander



Ref.	Ø x Altura Cms.
<b>557</b>	<b>26 x 9</b>
<b>3320</b>	<b>30 x 12</b>



### Centrifugadora 3 L.

Essoreuse a légumes  
Salad dryer

**Retráctil**

Rétractable - Retractable

Ref.	Ø x Altura Cms.
<b>425</b>	<b>24 x 13</b>

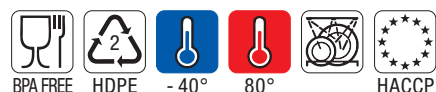

### Salero Cocina 1 Kg.

Saliere 1 Kg.  
Salt Box 1 Kg.

Ref.	Tamaño Cms.
<b>572</b>	<b>16 x 8 x 12</b>



### Aros Emplatar

Plastic Cercles  
Plastic Rings

Ref.	Ø x Altura Cms.	Pack
<b>141</b>	<b>7 x 4,5</b>	<b>4</b>
<b>142</b>	<b>8 x 4,5</b>	<b>4</b>
<b>144</b>	<b>10 x 4,5</b>	<b>4</b>
<b>145</b>	<b>12 x 4,5</b>	<b>1</b>

Set 4 Uds.

Ref.	Ø Cms.
<b>140</b>	<b>7 - 8 - 10 - 12</b>





## Tabla de cortar "Mármol"

Planche à découper "Marbre"  
"Marble" Cutting board

Ref.	Tamaño Cms.
<b>542</b>	<b>30 x 20 x 0,5</b>

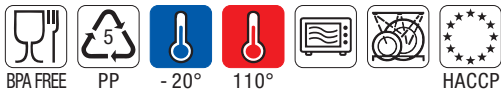

## Tabla de cortar SLIM

Planche à découper  
Cutting board

Ref.	Tamaño Cms.
<b>1112</b>	<b>34,5 x 24,5 x 0,2</b>

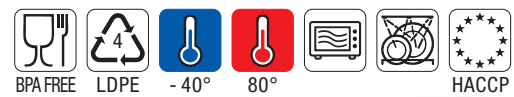

## Hueveras

Coquetieres  
Egg Storers

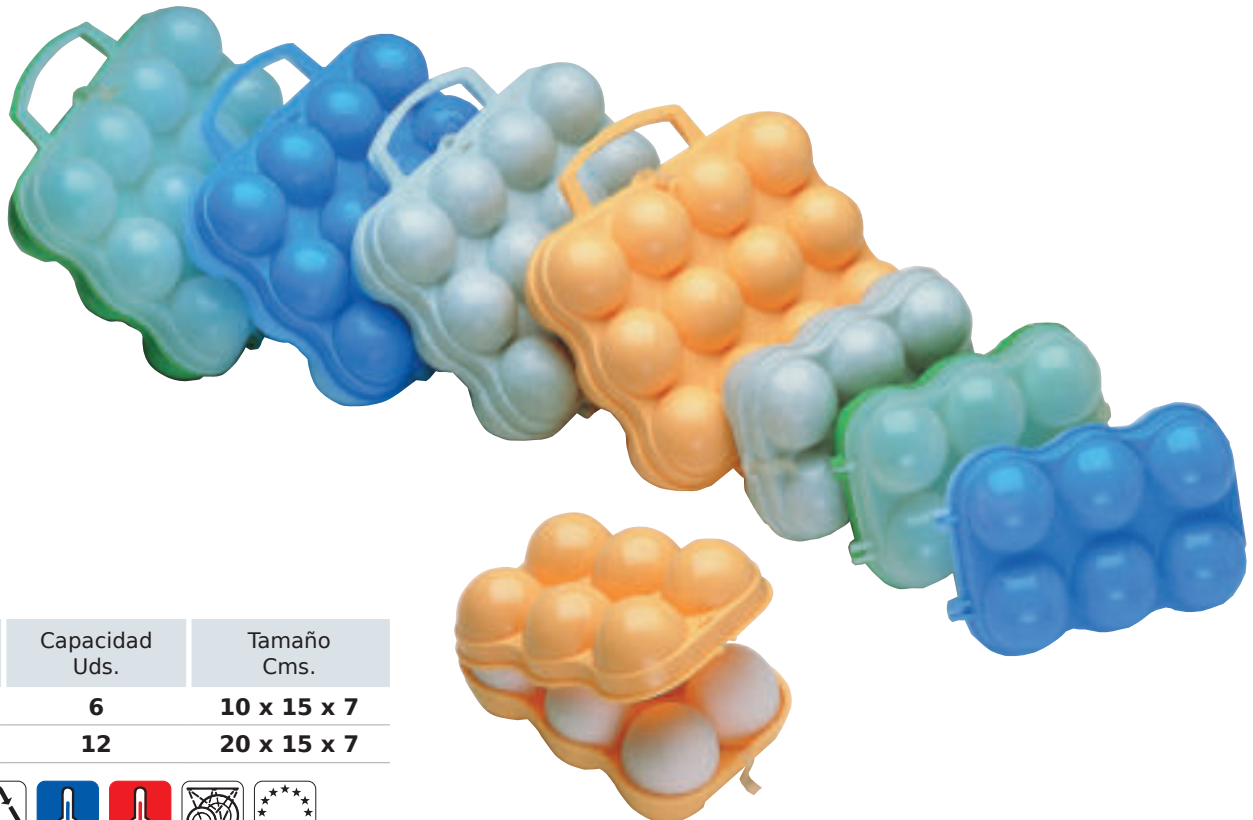

Ref.	Capacidad Uds.	Tamaño Cms.
<b>554</b>	<b>6</b>	<b>10 x 15 x 7</b>
<b>584</b>	<b>12</b>	<b>20 x 15 x 7</b>

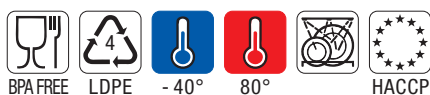

## Embudos

Entonnoirs  
Funnels

Ref.	Ø x Altura Cms.	Ø Inferior Cms.
<b>775</b>	<b>9 x 10</b>	<b>1,0</b>
<b>774</b>	<b>11 x 12,5</b>	<b>1,2</b>
<b>773</b>	<b>13,5 x 15</b>	<b>1,4</b>
<b>772</b>	<b>17 x 18,5</b>	<b>1,6</b>
<b>771</b>	<b>19 x 20</b>	<b>1,8</b>

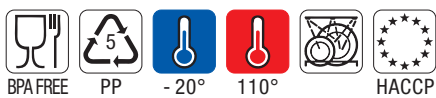

## Embudos con filtro inox

Entonnoirs avec filtre  
Filter Funnels

Ref.	Ø x Altura Cms.	Ø Inferior Cms.
<b>3342</b>	<b>22 x 22</b>	<b>2,0</b>
<b>3343</b>	<b>26 x 25,5</b>	<b>2,4</b>
<b>3344</b>	<b>30 x 28,5</b>	<b>2,6</b>
<b>3345</b>	<b>35 x 32</b>	<b>2,8</b>

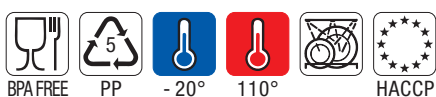

## Libradores

Pelles à farine  
Scoops



Ref.	Tamaño Cms.	Cls.
<b>3380</b>	<b>18 / 12 x 6</b>	<b>12</b>
<b>3381</b>	<b>24 / 15 x 8</b>	<b>30</b>
<b>3382</b>	<b>29 / 18 x 10</b>	<b>55</b>
<b>3383</b>	<b>33 / 22 x 12</b>	<b>95</b>
<b>3384</b>	<b>38 / 26 x 13</b>	<b>160</b>

## Libradores fondo plano LINEAL LAB

Pelles à farine fond plat  
Flat bottom Scoops



Ref.	Tamaño Cms.	Cls.
<b>371</b>	<b>18,5 / 12 x 6,5</b>	<b>10,5</b>
<b>372</b>	<b>24,5 / 15 x 8,8</b>	<b>26</b>
<b>373</b>	<b>29,5 / 18 x 10,5</b>	<b>44</b>
<b>374</b>	<b>34 / 22 x 11</b>	<b>67,5</b>
<b>375</b>	<b>40 / 27 x 13,5</b>	<b>160</b>

## Libradores fondo plano COLORES HACCP

Pelles à farine fond plat couleur HACCP  
Flat bottom color HACCP Scoops



Ref.	Tamaño Cms.	Cls.
<b>471</b>	<b>18,5 / 12 x 6,5</b>	<b>10,5</b>
<b>472</b>	<b>24,5 / 15 x 8,8</b>	<b>26</b>
<b>473</b>	<b>29,5 / 18 x 10,5</b>	<b>44</b>
<b>474</b>	<b>34 / 22 x 11</b>	<b>67,5</b>
<b>475</b>	<b>40 / 27 x 13,5</b>	<b>160</b>





### Botes Nevera herméticos

*Boîtes hermétiques  
Hermetic ice-box*

Ref.	Capacidad Lts.	Ø x Altura Cms.
<b>757</b>	<b>0,5</b>	<b>11 x 10</b>
<b>756</b>	<b>1</b>	<b>11 x 15</b>
<b>760</b>	<b>1,5</b>	<b>11 x 22</b>

### Con tapón vertedor

*Avec verseur  
With spill*

Ref.	Capacidad Lts.	Ø x Altura Cms.
<b>457</b>	<b>0,5</b>	<b>11 x 10</b>
<b>456</b>	<b>1</b>	<b>11 x 15</b>
<b>460</b>	<b>1,5</b>	<b>11 x 22</b>



### Botes cocina rectangulares OSLO con Cierre Hermético

*Boîtes de Conservation Join hermetique  
Kitchen canister with hermetic seal*

Ref.	Capacidad Lts.	Tamaño Cms.
<b>1801</b>	<b>0,85</b>	<b>17 x 11 x 9</b>
<b>1802</b>	<b>1,2</b>	<b>17 x 11 x 10,5</b>
<b>1803</b>	<b>1,7</b>	<b>17 x 11 x 14,5</b>
<b>1804</b>	<b>2,6</b>	<b>17 x 11 x 21,5</b>

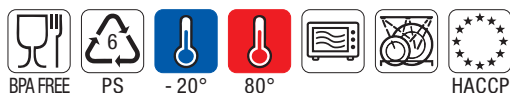

## Jarra HORECA 1,8 L.

*Pichet 1,8 L.*

*Jug 1,8 L.*

Ref.	Tamaño Cms.
<b>180</b>	<b>10,5 x 14 x 23</b>

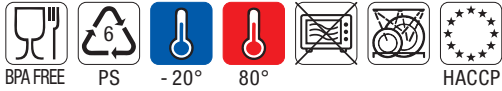

## Jarra HORECA 1,8 L. con tapa

*Pichet 1,8 L. avec couvercle*

*Jug 1,8 L. with cover*

Ref.	Tamaño Cms.
<b>181</b>	<b>10,5 x 14 x 23</b>

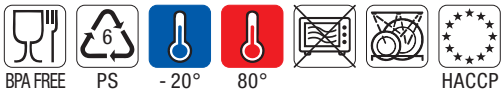

## Jarra Hermética 1,5 L. con tapa

*Pichet Hermétique 1,5 L.*

*Hermetic Jug 1,5 L.*

Ref.	Tamaño Cms.
<b>1120</b>	<b>19 x 10 x 20</b>



### Taza-Mug 33 cc

Tasse  
Mug



Ref.	Ø x Altura Cms.
<b>693</b>	<b>8,5 x 9</b>



### Tazón Desayuno 1/2 L.

Bol à céréales  
Cornflakes bowl



Ref.	Ø x Altura Cms.
<b>566</b>	<b>12 x 7,5</b>



### Cuenco Ceramic

Bol Ceramik  
Bowl Ceramik



Ref.	Capacidad Lts.	Ø x Altura Cms.
<b>117</b>	<b>1</b>	<b>17,5 x 6</b>

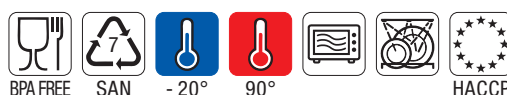

## Vasos

Verres  
Glasses



### Vaso Formas

Gobelet glacé  
Glaze glass



Ref.	Capacidad Cls.	Ø x Altura Cms.
<b>770</b>	<b>25</b>	<b>7 x 9</b>

### Vaso Liso

Gobelet lisse  
Bright glass



Ref.	Capacidad Cls.	Ø x Altura Cms.
<b>569</b>	<b>25</b>	<b>7 x 9,5</b>

### Vaso Grande

Verre Grand  
Big glass



Ref.	Capacidad Cls.	Ø x Altura Cms.
<b>777</b>	<b>45</b>	<b>8,5 x 12</b>

### Vaso Acrílico

Verre Acrylique  
Acrylic Glass

Ref.	Capacidad Cls.	Ø x Altura Cms.
<b>470</b>	<b>25</b>	<b>7 x 9</b>

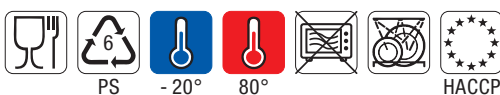



## Vasos y Copas Acrílicos

### Verres et Coupes Acryliques Acrylic Glasses and Cups

#### Vaso Cerveza 34 cl.

Verre à bière  
Beer glass



Ref.	Ø x Altura Cms.
<b>4019</b>	<b>7 x 17,3</b>

#### Copa Gin Tonic 50 cl.

Gin Tonic Coupe  
Gin Tonic Cup



Ref.	Ø x Altura Cms.
<b>4540</b>	<b>11 x 18</b>

#### Vaso Tubo

Verre Tube  
Tube glass



Ref.	Capacidad CLs.	Ø x Altura Cms.
<b>4008</b>	<b>30</b>	<b>6,3 x 15,4</b>
<b>4090</b>	<b>25</b>	<b>5,2 x 15,4</b>

#### Copa Flauta 16 cl

Coupe de flûte  
Flute Cup



Ref.	Ø x Altura Cms.
<b>4395</b>	<b>7 x 19,5</b>

#### Copa Vino / Agua 26 cl.

Verre à Vin/Eau  
Wine/Water Cup



Ref.	Ø x Altura Cms.
<b>4022</b>	<b>7,7 x 15,4</b>

#### Vaso Bajo

Verre Bas  
Short glass



Ref.	Capacidad CLs.	Ø x Altura Cms.
<b>4012</b>	<b>33</b>	<b>8 x 8</b>
<b>4356</b>	<b>37</b>	<b>8 x 8</b>

Caipiriña

Caipiriña ECO

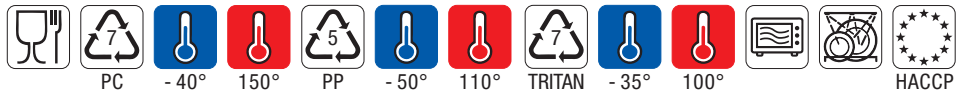

## Vaso Facetas PRESTIGE

Verre Facetas PRESTIGE  
Facetas Glass PRESTIGE



Ref.		Capacidad Cls.	Ø x Altura Cms.
<b>4282</b>	<b>Vaso Chupito</b> <i>Verre à liqueur / Shot glass</i>	<b>4</b>	<b>4,5 x 5,3</b>
<b>4272</b>	<b>Vaso Prestige Bajo</b> <i>Verre Prestige Bas / Prestige glass Small</i>	<b>33</b>	<b>8,7 x 10</b>
<b>4353</b>	<b>Vaso Prestige Medio</b> <i>Verre Prestige Moyen / Prestige glass Medium</i>	<b>40</b>	<b>8 x 12</b>
<b>4292</b>	<b>Vaso Prestige Alto</b> <i>Verre Prestige Haut / Prestige glass Tall</i>	<b>33</b>	<b>7,4 x 14</b>

## Vaso Whisky

Verre à Whisky  
Whisky glass



## Vaso Facetas ECO

Verre Facetas ECO  
Facetas Glass ECO



Ref.	Capacidad CLs.	Ø x Altura Cms.
<b>4013</b>	<b>30</b>	<b>8 x 8</b>

Ref.		Capacidad Cls.	Ø x Altura Cms.
<b>4354</b>	<b>Vaso Eco Bajo</b> <i>Verre Eco Bas / Eco glass Small</i>	<b>33</b>	<b>8,7 x 10</b>
<b>4293</b>	<b>Vaso Eco Medio</b> <i>Verre Eco Moyen / Eco glass Medium</i>	<b>40</b>	<b>8 x 12</b>
<b>4355</b>	<b>Vaso Eco Alto</b> <i>Verre Eco Haut / Eco glass Tall</i>	<b>33</b>	<b>7,4 x 14</b>



## Platos

Assiettes  
Dishes



Ref.		Ø x Altura Cms.
<b>797</b>	<b>Mixto / Mixte / Mix</b>	<b>20</b>
<b>590</b>	<b>Llano / Plate / Flat</b>	<b>23</b>
<b>589</b>	<b>Hondo / Creuse / Soup</b>	<b>23</b>

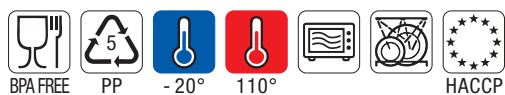

## Platos Melamina

Vaisselle melamine  
Melamine ware



Ref.		Ø Cms.
<b>248</b>	<b>Sopero / Creuse / Soup</b>	<b>23</b>
<b>251</b>	<b>Llano / Plate / Flat</b>	<b>25</b>
<b>250</b>	<b>Postre / Dessert / Dessert</b>	<b>20</b>



## Platos Pulpo y Tapas

Plats à poulpe  
Octopus dish



Ref.	Modelo	Ø x Altura Cms.
<b>849</b>	14	<b>14 x 2</b>
<b>851</b>	18	<b>17,5 x 2</b>
<b>852</b>	20	<b>19,5 x 2</b>
<b>854</b>	24	<b>23,5 x 2</b>
<b>855</b>	28	<b>28 x 2</b>
<b>856</b>	30	<b>29,5 x 2</b>

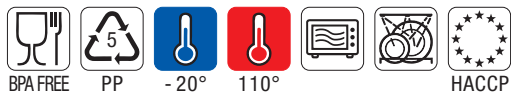

## Plato Patatas Fritas 4 salsas

Plat a frites 4 sauces  
French fries dish 4 sauces



Ref.	Tamaño Cms.
<b>115</b>	<b>23 x 23 x 2</b>





Platos "Pizarra"

Plats "Ardoise"  
"Slate" dishes



Ref.	Ø x Altura Cms.
<b>862</b>	<b>25 x 0,5</b>
<b>863</b>	<b>30 x 0,5</b>
<b>864</b>	<b>35 x 0,5</b>



Platos "Pizarra"

Plats "Ardoise"  
"Slate" dishes



Ref.	Tamaño Cms.
<b>871</b>	<b>20 x 17,5 x 0,5</b>
<b>873</b>	<b>30 x 20 x 0,5</b>



## Rabaneras

Raviers  
Oval small plates



Ref.	Tamaño Cms.
<b>103</b>	<b>13 x 7 x 2</b>
<b>104</b>	<b>15 x 8 x 2</b>
<b>105</b>	<b>17,5 x 10 x 2</b>

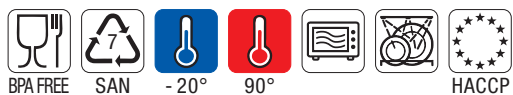

## Bol Cuadrado 20 cl.

Bol carré  
Square Bol



Ref.	Tamaño Cms.
<b>108</b>	<b>8,5 x 8,5 x 2,5</b>
<b>109</b>	<b>10 x 10 x 3</b>
<b>110</b>	<b>11,5 x 11,5 x 3,5</b>



## Bandeja de servir Hotel

Plateau de chambre HOTEL  
Room's Tray HOTEL



Ref.	Tamaño Cms.
<b>1300</b>	<b>51 x 36 x 3,5</b>



## Bandejas Expositoras

Plateaux d'exposition  
Display trays



Ref.	Nº	Tamaño Cms.
<b>241</b>	<b>1</b>	<b>20 x 15 x 1,2</b>
<b>242</b>	<b>2</b>	<b>28 x 19 x 1,2</b>
<b>243</b>	<b>3</b>	<b>35 x 24 x 1,2</b>
<b>244</b>	<b>4</b>	<b>42 x 30 x 1,2</b>
<b>245</b>	<b>5</b>	<b>50 x 36 x 1,2</b>
<b>246</b>	<b>6</b>	<b>58,5 x 41,5 x 3</b>

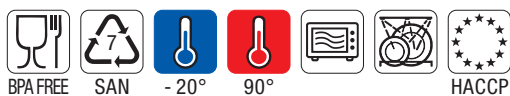

## Bandejas Expositoras Negras

Plateaux d'exposition Noire  
Black Display trays



## Bandejas PL.

Plateaux PL.  
PL. trays



Ref.	Tamaño Cms.
<b>2200</b>	<b>28 x 21 x 2</b>
<b>2201</b>	<b>33 x 25 x 2</b>
<b>2202</b>	<b>38 x 28 x 2</b>





## Bandejas Mostrador

Plateaux Vitrine  
Market trays



Ref.	Tamaño Cms.
<b>281</b>	<b>28 x 20 x 1,5</b>
<b>282</b>	<b>35 x 25 x 2</b>
<b>283</b>	<b>42 x 30 x 2,5</b>

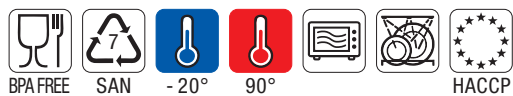

## Cubetas Nevera

Bacs Fonds  
Deep Trays



Ref.	Capacidad Lts.	Tamaño Cms.
<b>634</b>	<b>0,5</b>	<b>17 x 11 x 4</b>
<b>633</b>	<b>1</b>	<b>23 x 15 x 5</b>
<b>632</b>	<b>2</b>	<b>31 x 20 x 5</b>





## Queseras

*Cloche à Fromage*  
*Cheese Keepers*



*Base en Madera*  
*Base en Bois*  
*Wood Base*

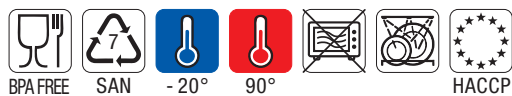

Ref.	Modelo	Ø x Altura exterior Cms.	Ø x Altura interior Cms.
<b>487</b>	<b>20</b>	<b>23,5 x 15</b>	<b>19 x 11</b>
<b>488</b>	<b>24</b>	<b>26,5 x 19</b>	<b>22,5 x 13,5</b>

## Tarteras

*Cloche à pâtisseries*  
*Cake Keepers*



Ref.	Ø x Altura exterior Cms.	Ø x Altura interior Cms.
<b>1610</b>	<b>28 x 10</b>	<b>24 x 9</b>
<b>1611</b>	<b>28 x 13</b>	<b>24 x 12</b>
<b>1612</b>	<b>34,5 x 13</b>	<b>30 x 12</b>

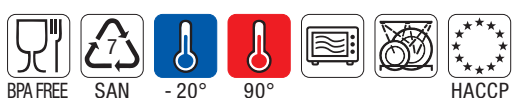

## Cubertero Pequeño

Range Couverts  
Cutlery

Ref.	Tamaño Cms.
<b>1473</b>	<b>24,5 x 33</b>

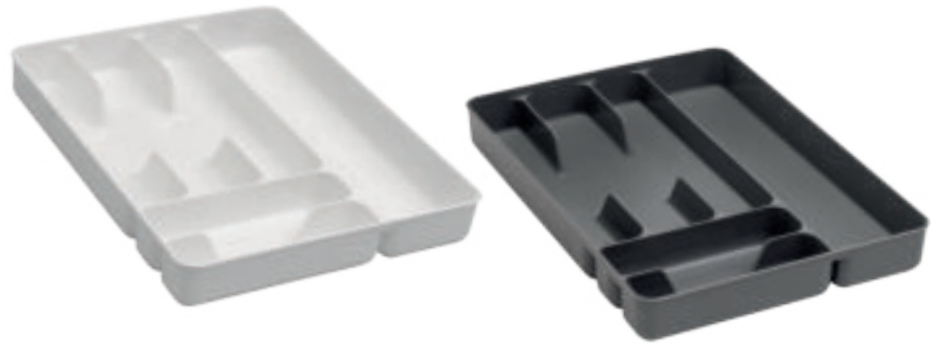
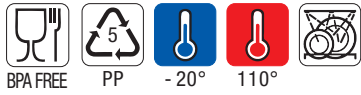

## Cubertero Grande

Range-couverts  
Cutlery

Ref.	Tamaño Cms.
<b>683</b>	<b>30 x 34</b>



## Cubetas modulares

Bacs modulaires  
Modulars boxes

Ref.	Tamaño Cms.
<b>264</b>	<b>8 x 8 x 5</b>
<b>265</b>	<b>15 x 8 x 5</b>
<b>266</b>	<b>23 x 8 x 5</b>
<b>276</b>	<b>23 x 15 x 5</b>
<b>267</b>	<b>30 x 8 x 5</b>
<b>268</b>	<b>38 x 8 x 5</b>
<b>278</b>	<b>38 x 15 x 5</b>

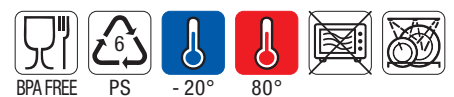

## Estante Multiuso

Multi-serviteur  
Multiself Box

Pequeño - Petite - Little

Ref.	Tamaño Cms.
<b>826</b>	<b>24 x 10 x 10</b>

Grande - Grand - Large

Ref.	Tamaño Cms.
<b>758</b>	<b>32 x 10 x 10</b>



## Expositor 24 Cepillos Lavavajillas

Set 24 Brosses Assiettes  
24 Dish Brush Display

Ref.	Tamaño Cms.
<b>324</b>	<b>22 x 5,5 x 4</b>



## Escurrecubiertos OVAL

Egouttoir couverts  
Cutlery drainer

Ref.	Tamaño Cms.
<b>1395</b>	<b>9 x 16 x 11 / 14</b>





## Escurrevajillas 16 platos

Egouttoir vaisselle 16 a.  
Dish drainer 16 d.



Ref.	Tamaño Cms.
<b>1348</b>	<b>39 x 44 x 8</b>



## Salvaplatos

Tapis Lavoir  
Sink Mats

Ref.	Tamaño Cms.
<b>836</b>	<b>24 x 27</b>
<b>837</b>	<b>27 x 30</b>
<b>838</b>	<b>32 x 32</b>
<b>840</b>	<b>Ø 32</b>

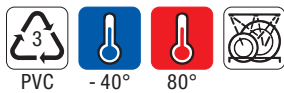

## Multiprotector Caucho 100%

Tapis Protecteur  
Rubber Mat

Ref.	Tamaño Cms.
<b>2000</b>	<b>50 x 26</b>
<b>2001</b>	<b>50 x 40</b>
<b>2002</b>	<b>80 x 50</b>

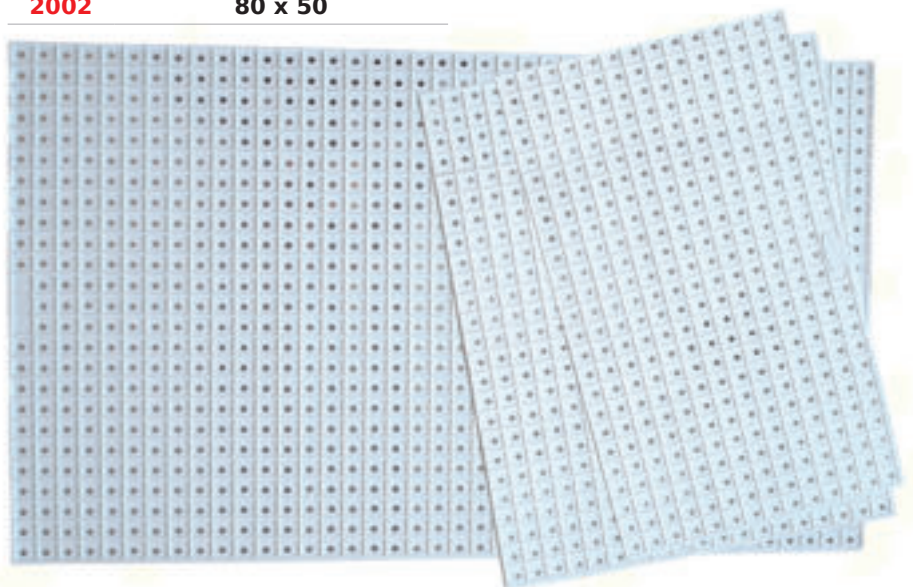
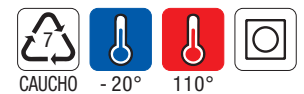





Pág. 31



Pág. 32



Pág. 32



Pág. 32



Pág. 33



Pág. 33



Pág. 34



Pág. 35



Pág. 35



Pág. 36



Pág. 36



# ORDENACIÓN

ORGANISATEURS  
ORGANISERS

## Cubetas modulares

Bacs modulaires  
Modulars boxes



Ref.	Tamaño Cms.
<b>264</b>	<b>8 x 8 x 5</b>
<b>265</b>	<b>15 x 8 x 5</b>
<b>266</b>	<b>23 x 8 x 5</b>
<b>276</b>	<b>23 x 15 x 5</b>
<b>267</b>	<b>30 x 8 x 5</b>
<b>268</b>	<b>38 x 8 x 5</b>
<b>278</b>	<b>38 x 15 x 5</b>

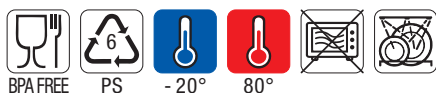

### Cubetas Apilables Hondas

*Cuvettes carrées*  
*Tubs*

Ref.	Capacidad Lts.	Tamaño Cms.
<b>312</b>	<b>12</b>	<b>39,5 x 29,5 x 16,5</b>
<b>315</b>	<b>15</b>	<b>39,5 x 29,5 x 21,5</b>



### Tapa Cubetas Hondas 12 y 15 L.

*Couvercle Cuvettes*  
*Food bins lid*



Ref.	Tamaño Cms.
<b>627</b>	<b>40 x 30 x 3</b>



### Tapa Cubetas 12, 15 y 26 L.

*Couvercle Cuvettes*  
*Food bins lid*



Ref.	Para Cubeta	Tamaño Cms.
<b>827</b>	<b>828 y 832</b>	<b>20 x 28 x 3</b>
<b>829</b>	<b>834</b>	<b>28 x 31,5 x 3</b>

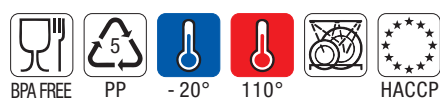



## Cubetas Rectangulares

Plateaux rectangulaires  
Food rectangular containers

Ref.	Capacidad Lts.	Tamaño Cms.
<b>151</b>	<b>2</b>	<b>30 x 20,5 x 6</b>
<b>152</b>	<b>3</b>	<b>34,5 x 23,5 x 7,5</b>
<b>153</b>	<b>5</b>	<b>43,5 x 28,5 x 8</b>
<b>154</b>	<b>8</b>	<b>49,5 x 33,5 x 8</b>
<b>155</b>	<b>10</b>	<b>54 x 38,5 x 8</b>
<b>156</b>	<b>15</b>	<b>60 x 40 x 9</b>

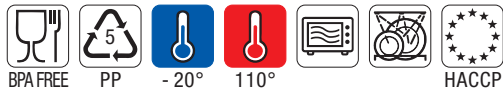

## Cesta

Pannier Basket



Ref.	Capacidad Lts.	Tamaño Cms.
<b>6045</b>	<b>22</b>	<b>43 x 32 x 24</b>

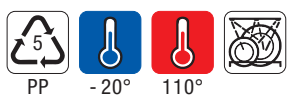



Cajas Apilables-Encajables

Caisses Empilables-Gerbables  
Canisters Stackables



Apilable y  
Encajable  
SIN TAPA

Ref.	Capacidad Lts.	Tamaño exterior Cms.	Tamaño interior Cms.
<b>3350</b>	<b>50</b>	<b>55 x 42 x 29</b>	<b>45,5 x 38 x 28,5</b>
<b>3354</b>	<b>65</b>	<b>62 x 44 x 33</b>	<b>54 x 39,5 x 32,5</b>
<b>3390</b>	<b>90</b>	<b>74 x 46 x 36</b>	<b>63,5 x 42 x 35</b>



## Cajas Rejilla Apilables-Encajables

Caisses canèe Empilables-Gerbables  
Grilled Containers stackables

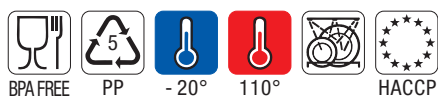

Ref.	Capacidad Lts.	Tamaño exterior Cms.	Tamaño interior Cms.
<b>3352</b>	<b>50</b>	<b>55 x 42 x 29</b>	<b>45,5 x 38 x 28,5</b>
<b>3356</b>	<b>65</b>	<b>62 x 44 x 33</b>	<b>54 x 39,5 x 32,5</b>

## Tapas cajas Apilables

Couvercles caisses canèe Empilables  
Lids containers Stackables

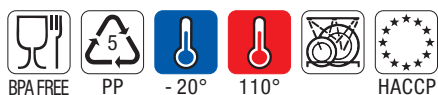

Ref.	Capacidad Lts.	Tamaño Cms.
<b>3360</b>	<b>50</b>	<b>56 x 43 x 2,5</b>
<b>3361</b>	<b>65</b>	<b>63 x 45 x 2,5</b>
<b>3362</b>	<b>90</b>	<b>75 x 47 x 2,5</b>

## Cubetas Charcuteras

Bacs à charcuterie  
Butchers



Ref.	Capacidad Lts.	Tamaño Cms.
<b>504</b>	<b>4</b>	<b>33,5 x 24 x 7,5</b>
<b>506</b>	<b>6</b>	<b>39,5 x 26,5 x 8</b>
<b>510</b>	<b>12</b>	<b>48,5 x 33,5 x 9</b>
<b>516</b>	<b>17</b>	<b>53 x 39,5 x 10</b>
<b>520</b>	<b>21</b>	<b>48,5 x 33,5 x 16</b>

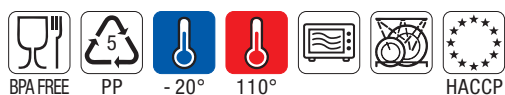

## Tapas Cubetas Charcuteras

Couvercles bacs à charcuterie  
Lids for butchers



Ref.	Capacidad Lts.	Tamaño Cms.
<b>921</b>	<b>4</b>	<b>34 x 24 x 2,5</b>
<b>922</b>	<b>6</b>	<b>40 x 26,5 x 2,5</b>
<b>923</b>	<b>12 / 21</b>	<b>49 x 33,5 x 2,5</b>
<b>924</b>	<b>17</b>	<b>53,5 x 39,5 x 2,5</b>

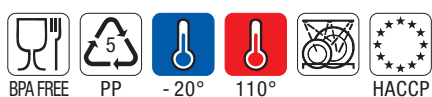

 Pág. 38	 Pág. 38	 Pág. 39	 Pág. 39	 Pág. 40
 Pág. 41	 Pág. 41	 Pág. 41	 Pág. 42	 Pág. 42
 Pág. 43	 Pág. 43	 Pág. 43	 Pág. 44	 Pág. 44
 Pág. 45	 Pág. 46	 Pág. 46	 Pág. 47	 Pág. 47
 Pág. 47	 Pág. 48	 Pág. 48	 Pág. 49	 Pág. 49



## LIMPIEZA

NETTOYAGE  
CLEANING



## Cubetas cuadradas

*Cuvettes carrées*  
*Tubs*



Ref.	Capacidad Lts.	Tamaño exterior Cms.	Tamaño interior Cms.
<b>715</b>	<b>6</b>	<b>26,5 x 26,5 x 15</b>	<b>22 x 22 x 13,5</b>
<b>716</b>	<b>7,5</b>	<b>30,5 x 30,5 x 12</b>	<b>25,5 x 25,5 x 11,5</b>
<b>714</b>	<b>10</b>	<b>30,5 x 30,5 x 17,5</b>	<b>25,5 x 25,5 x 17</b>
<b>713</b>	<b>14</b>	<b>35 x 35 x 19,5</b>	<b>30 x 30 x 19</b>

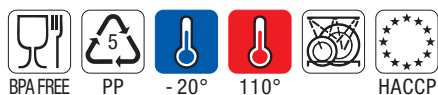

## Jofainas

*Bassines rondes*  
*Round basins*



Ref.	Capacidad Lts.	Ø x Altura exterior Cms.	Ø x Altura interior Cms.
<b>730</b>	<b>1</b>	<b>23,5 x 6</b>	<b>20 x 5,5</b>
<b>729</b>	<b>2</b>	<b>27,5 x 7</b>	<b>24 x 6,5</b>
<b>728</b>	<b>5</b>	<b>31,5 x 9</b>	<b>28 x 8,5</b>
<b>653</b>	<b>7</b>	<b>36,5 x 11</b>	<b>32 x 10,5</b>
<b>727</b>	<b>11</b>	<b>40,5 x 14</b>	<b>36 x 13,5</b>
<b>726</b>	<b>15</b>	<b>45 x 16</b>	<b>40 x 15,5</b>

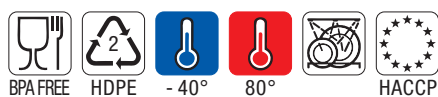

## Barreños

Baquets Ronds  
Tubs



Ref.	Capacidad Lts.	Ø x Altura exterior Cms.	Ø x Altura interior Cms.
<b>654</b>	<b>12</b>	<b>38 x 19,5</b>	<b>34,5 x 19</b>
<b>655</b>	<b>18</b>	<b>42 x 21,5</b>	<b>38,5 x 21</b>
<b>652</b>	<b>30</b>	<b>48 x 22,5</b>	<b>43,5 x 22</b>
<b>719</b>	<b>40</b>	<b>48 x 33,5</b>	<b>43,5 x 33</b>
<b>699</b>	<b>50</b>	<b>48 x 41,5</b>	<b>43,5 x 41</b>

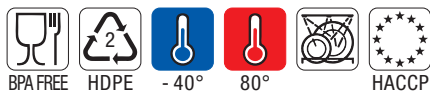

## Cubos

Seaus  
Buckets



Ref.		Capacidad Lts.	Ø x Altura Cms.
<b>785</b>	<b>Graduado</b> <i>Gradué / Graduated</i>	<b>7</b>	<b>25 x 23</b>
<b>641</b>	<b>Graduado</b> <i>Gradué / Graduated</i>	<b>11</b>	<b>30 x 25</b>
<b>752</b>	<b>Vertedor</b> <i>Verseur / Spill</i>	<b>12</b>	<b>29 x 26</b>
<b>642</b>	<b>Graduado y Vertedor</b> <i>Gradué et Verseur / Graduated and Spill</i>	<b>13</b>	<b>30 x 29</b>

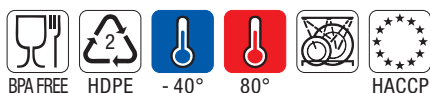

**Kit Soporte + Tapa**  
**Apertura automática para**  
**Cubeta Orgánico 12 L.**

*Kit couvercle + support.*  
*Ouverture automatique pour*  
*Poubelle Organique 12 L.*

*Lid Kit.*  
*Automatic opening for 12 L.*  
*Organic bin*

Ref.  
**427**

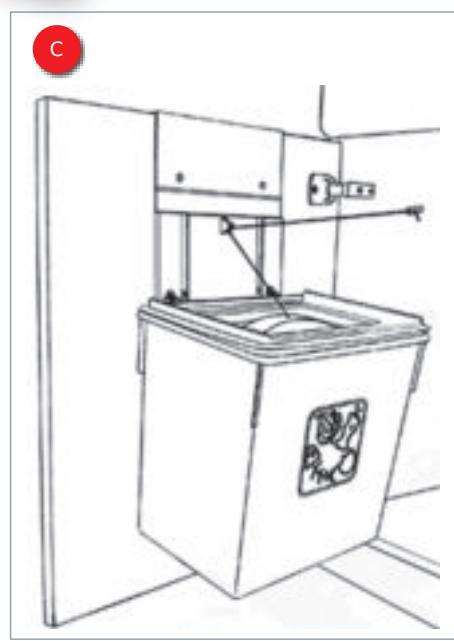
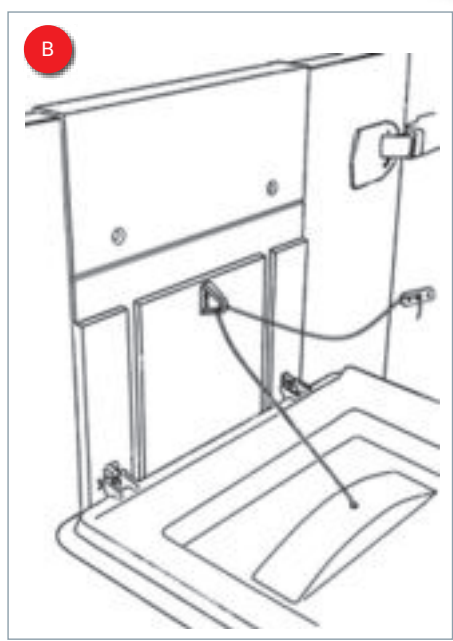
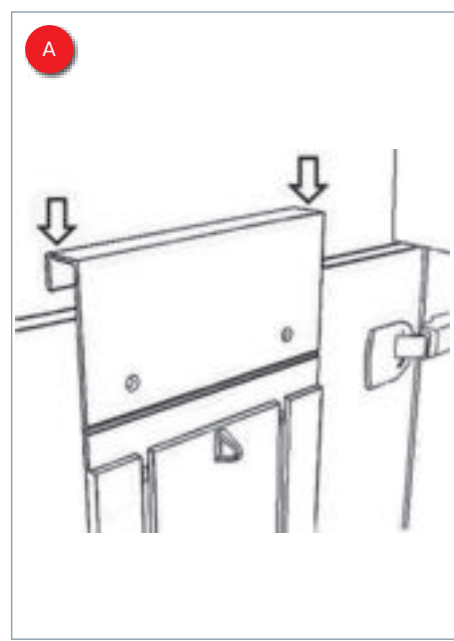
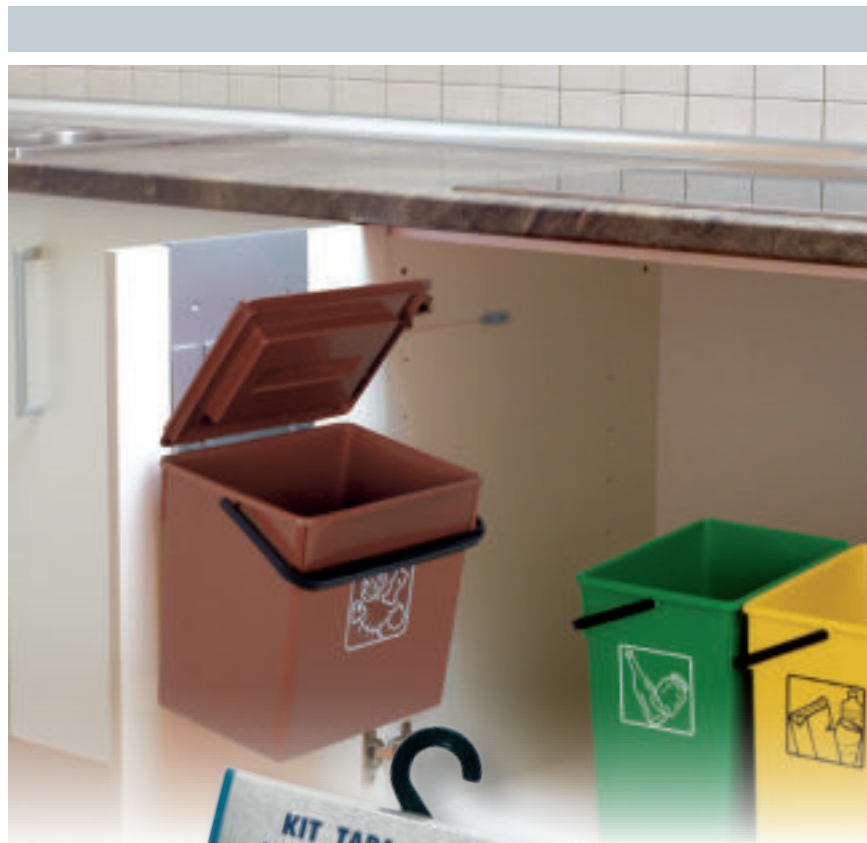
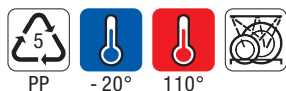

**Cubeta Orgánico 12 L.**

*Poubelle Organique  
Organic bin*



Ref.	Capacidad Lts.	Tamaño exterior Cms.	Tamaño interior Cms.
<b>428</b>	<b>12</b>	<b>28 x 20,5 x 27</b>	<b>26 x 18,5 x 26,5</b>

**Cubeta Reciclar 15 L.**

*Poubelle recyclage  
Recycling bin*



Ref.	Capacidad Lts.	Tamaño exterior Cms.	Tamaño interior Cms.
<b>432</b>	<b>15</b>	<b>20 x 28 x 33,5</b>	<b>18 x 26 x 33</b>

**Cubeta Reciclar 26 L.**

*Poubelle recyclage / Recycling bin*



Ref.	Capacidad Lts.	Tamaño exterior Cms.	Tamaño interior Cms.
<b>434</b>	<b>26</b>	<b>28,5 x 31,5 x 38</b>	<b>24,4 x 28 x 37,5</b>



### Tapa Cubetas 12, 15 y 26 L.

*Couvercle Cuvettes*  
*Bins lid*

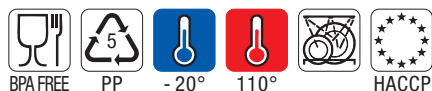

12 L.

Ref.	Tamaño Cms.
<b>827</b>	<b>20 x 28 x 3</b>



15 L.

### Tapa para Cubetas 26 L.

*Couvercle pour Cuvettes de 26 L.*  
*Lid for 26 L. Bins*



Ref.	Tamaño Cms.
<b>829</b>	<b>28 x 31,5 x 3</b>



26 L.

### Papeleras

*Corbeilles à papier*  
*Paper Bins*

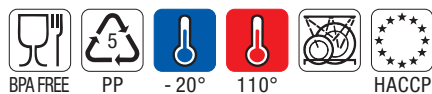

Ref.	Capacidad Lts.	Tamaño exterior Cms.	Tamaño interior Cms.
<b>831</b>	<b>8</b>	<b>25 x 18 x 23,5</b>	<b>23 x 16 x 23</b>
<b>828</b>	<b>12</b>	<b>28 x 20,5 x 27</b>	<b>26 x 18,5 x 26,5</b>
<b>832</b>	<b>15</b>	<b>28 x 20 x 33,5</b>	<b>26 x 18,5 x 33</b>
<b>834</b>	<b>26</b>	<b>31,5 x 28,5 x 38</b>	<b>28 x 24,5 x 37,5</b>



### Cubo Pedal Reciclar con aro sujeta-bolsa

*Poubelle a pedal Recyclage avec cercle tient sac*  
*Recycling pedal bin with bag holder*



Ref.	Capacidad Lts.	Tamaño Cms.
<b>436</b>	<b>28</b>	<b>33 x 29 x 49</b>

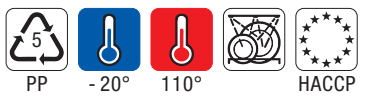

### Cubo pedal con aro sujeta-bolsa

*Poubelle à pédale avec cercle tient sac*  
*Pedal bin with bag holder*



Ref.	Capacidad Lts.	Tamaño Cms.
<b>433</b>	<b>28</b>	<b>33 x 29 x 49</b>



### Papelera tapa basculante

*Poubelles à couvercle-balancier*  
*Swing dustbins*



Ref.	Capacidad Lts.	Tamaño Cms.
<b>4500</b>	<b>50</b>	<b>40 x 37 x 77</b>
<b>1341</b>	<b>25</b>	<b>32 x 25 x 46</b>

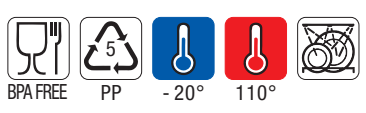

## Papelera Basculante "Media Luna"

*Poubelle inclinable "Demi-Lune"*  
*"Half Moon" Tilting Trash Can*

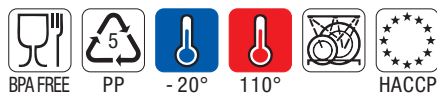

Ref.	Capacidad Lts.	Tamaño Cms.
<b>1357</b>	<b>10</b>	<b>27 x 22 x 33</b>
<b>1358</b>	<b>25</b>	<b>34 x 27 x 48</b>
<b>1359</b>	<b>45</b>	<b>40 x 31 x 63,5</b>

## Papelera Basculante Doble "Media Luna"

*Poubelle à double inclinaison "Demi-Lune"*  
*"Half Moon" Double Tilting Trash Can*

Ref.	Capacidad Lts.	Tamaño Cms.
<b>1354</b>	<b>50</b>	<b>54 x 34 x 48</b>



## Cubo 80 L. con tapa y ruedas

*Poubelle 80 L.  
avec couvercle et roues*

*Bin 80 L. with lid and wheels*



Ref.	Capacidad Lts.	Tamaño Cms.
<b>3080</b>	<b>80</b>	<b>45 x 50 x 77</b>

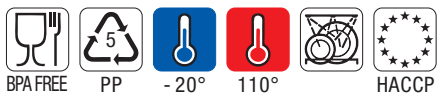

## Kit Pedal Metálico

*Kit de pédale métallique  
Metallic pedal kit*

Ref.

**3081**

- Plásticos, Tetrabrik y Env. metálicos  
*Plastiques, Tetrabrik et cont. en métal - Plastic, Tetrabrik and metal conts.*
- Envases de Vidrio - *Contenants en verre - Glass containers*
- Papel y Cartón - *Papier et Carton - Paper and Cardboard*
- Orgánico - *Organique - Organic*





## Cubos Basura sin tapa

*Pouvelles sans couvercle*  
*Garbage Bins without lid*

**Alta Resistencia**  
**Haute Résistance**  
**High Impact**

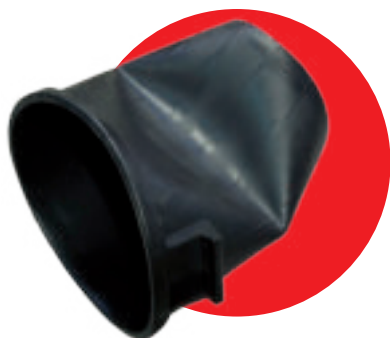

Ref.	Capacidad Lts.	Ø x Altura exterior Cms.	Ø x Altura interior Cms.
<b>4049</b>	<b>50</b>	<b>41 x 50</b>	<b>37,5 x 49</b>
<b>4074</b>	<b>75</b>	<b>45 x 63,5</b>	<b>40 x 62,5</b>
<b>4099</b>	<b>100</b>	<b>52 x 65,5</b>	<b>47,5 x 64</b>

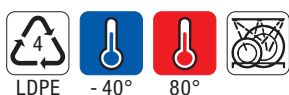

## Tapas Cubos Basura

*Couvercles Poubelles*  
*Lids garbage Bins*

Ref.	Capacidad Cls.	Ø x Altura Cms.
<b>4059</b>	<b>50</b>	<b>42 x 3</b>
<b>4079</b>	<b>75</b>	<b>46 x 3</b>
<b>4109</b>	<b>100</b>	<b>53 x 3</b>

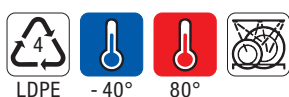

## Cubos Basura Reciclar sin tapa

*Poubelles recyclage sans couvercle*  
*Recycling Bins without lid*

Ref.	Capacidad Cls.	Ø x Altura Cms.
<b>4149</b>	<b>50</b>	<b>41 x 50</b>
<b>4174</b>	<b>75</b>	<b>45 x 63,5</b>
<b>4199</b>	<b>100</b>	<b>52 x 65,5</b>

- Plásticos, Tetrabrik y Env. metálicos  
*Plastiques, Tetrabrik et cont. en métal - Plastic, Tetrabrik and metal conts.*
- Envases de Vidrio - *Contenants en verre - Glass containers*
- Papel y Cartón - *Papier et Carton - Paper and Cardboard*
- Orgánico - *Organique - Organic*

## Cubo Basura

Poubelle  
Bin



Ref.	Capacidad Lts.	Ø Cms.
<b>678</b>	<b>17</b>	<b>33 x 29</b>

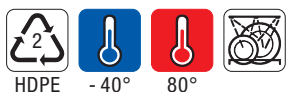

## Recogedor con mango

Pelle avec manché  
Dust Scraper



Ref.	Tamaño Cms.
<b>628</b>	<b>22 x 24 x 87</b>

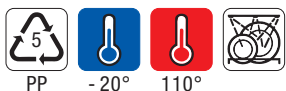

## Fregadora Practik

Balai Epongeur  
Polisher Mop



Ref.
<b>598</b>

## Recambio esponja Fregadora Practik Nylon

Éponge rechargeable  
Spare sponge



Ref.
<b>644</b>

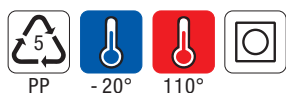





## Limpiatechos Telésopico

Tête de Loup  
Ceiling Brush



Ref.	Tamaño Mts.
<b>710</b>	<b>1,80</b>





 PVC
  -40°
  80°
  HACCP

## Desatascador

Débouchoir  
Plunger



Ref.	Ø x Altura Cms.
<b>1757</b>	<b>14 x 33</b>

 CAUCHO
  -20°
  110°
  HACCP

## Cenicero Melamina "LUCKY"

Cendrier melamine "LUCKY"  
Melamine ashtray "LUCKY"

Ref.	Ø x Altura Cms.
<b>794</b>	<b>13 x 3,5</b>



## Cenicero Melamina "DUQUE"

Cendrier melamine "DUQUE"  
Melamine ashtray "DUQUE"

Ref.	Ø x Altura Cms.
<b>796</b>	<b>10 x 4</b>



## Felpudo Caucho Extra

Paillason  
Rubber doormat

Ref.	Tamaño Cms.
<b>2016</b>	<b>53 x 37</b>
<b>2017</b>	<b>70 x 50</b>
<b>2018</b>	<b>80 x 60</b>
<b>2019</b>	<b>120 x 80</b>

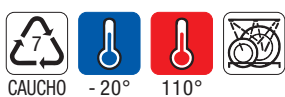



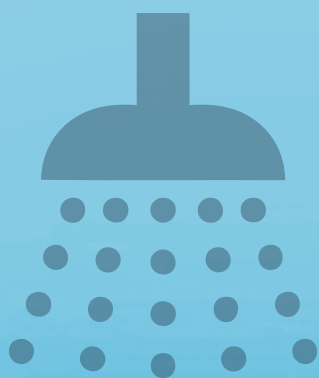

BAÑO

SALLE DE BAIN  
BATHROOM

### Bolsas Agua Caliente Caucho

*Bouillottes caoutchouc*  
*Rubber Hot Water Bottles*



*Forrada* - Doublé - Covered

Ref.	Capacidad Lts.
<b>1453</b>	<b>1,6</b>

*Superkent*

Ref.	Capacidad Lts.
<b>1711</b>	<b>1,6</b>

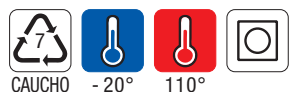

### Banqueta Alta Antideslizante con asa

*Tabouret Haut Anti-dérapant avec anse*

*Step Stool with Pads with handle*



Ref.	Tamaño Cms.
<b>2090</b>	<b>38 x 30 x 24,5</b>

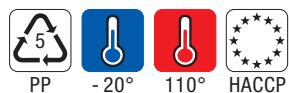

### Cubo Pedal Baño

*Poubelle sale de bains*  
*Pedal bin*



Ref.	Capacidad Lts.	Tamaño Cms.
<b>830</b>	<b>8</b>	<b>27 x 23 x 28</b>

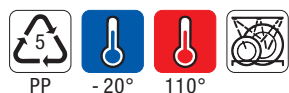



## Alfombras Caucho Bañera y Ducha "AGUA"

*Tapis bain / douche caoutchouc "AGUA"*

*Rubber bath / shower carpets "AGUA"*

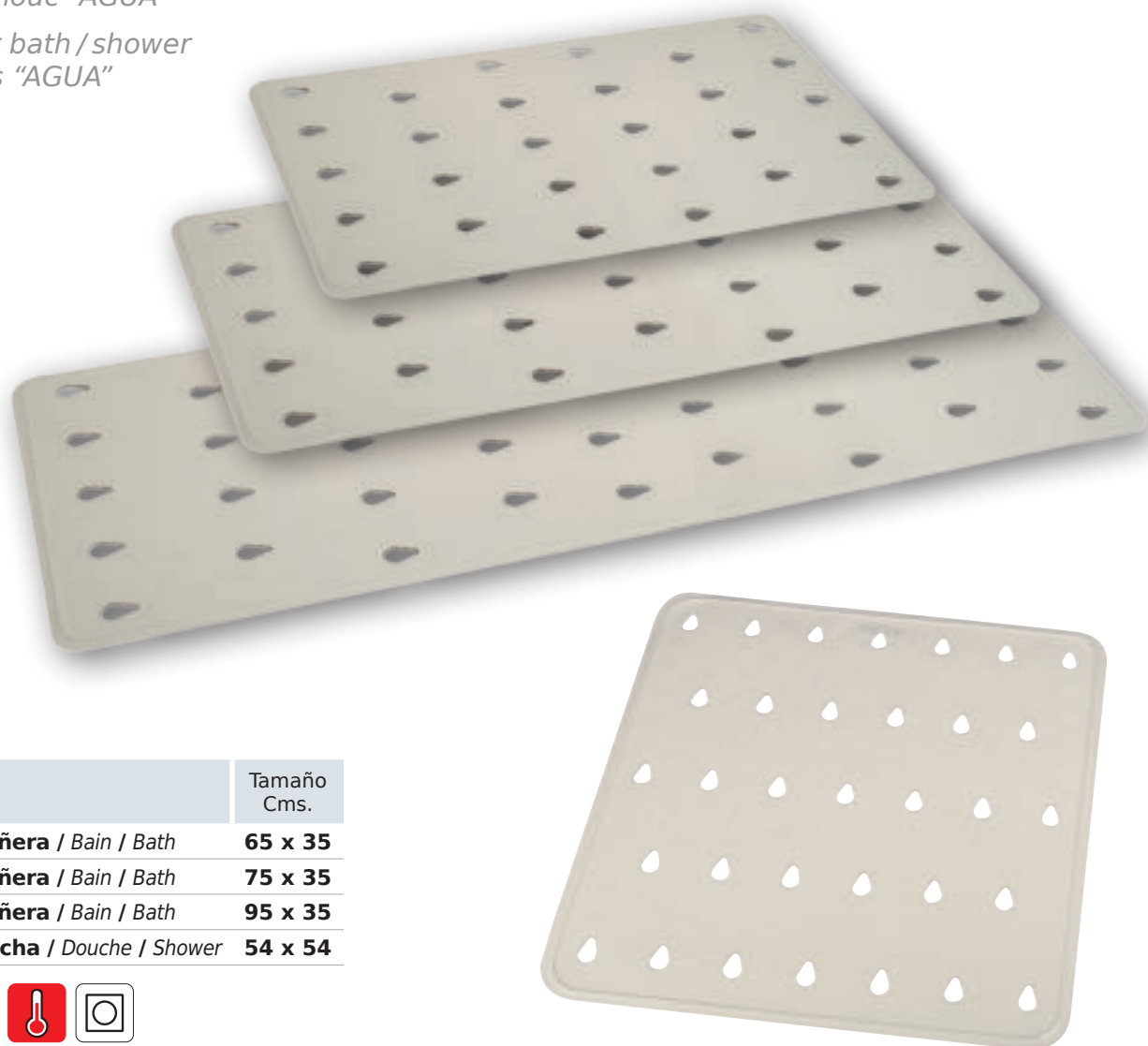

Ref.		Tamaño Cms.
<b>2011</b>	<b>Bañera / Bain / Bath</b>	<b>65 x 35</b>
<b>2012</b>	<b>Bañera / Bain / Bath</b>	<b>75 x 35</b>
<b>2013</b>	<b>Bañera / Bain / Bath</b>	<b>95 x 35</b>
<b>2014</b>	<b>Ducha / Douche / Shower</b>	<b>54 x 54</b>

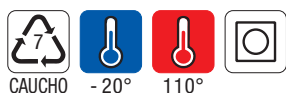

## Orinal con asa

*Vase de Nuit*  
*Bed Pans*



Ref.	Ø Cms.
<b>762</b>	<b>22</b>
<b>761</b>	<b>25</b>

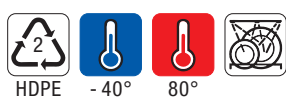

## Alfombras Caucho Bañera y Ducha "TOPOS"

*Tapis bain / douche caoutchouc "POIS"*

*Rubber bath / shower carpets "DOTS"*

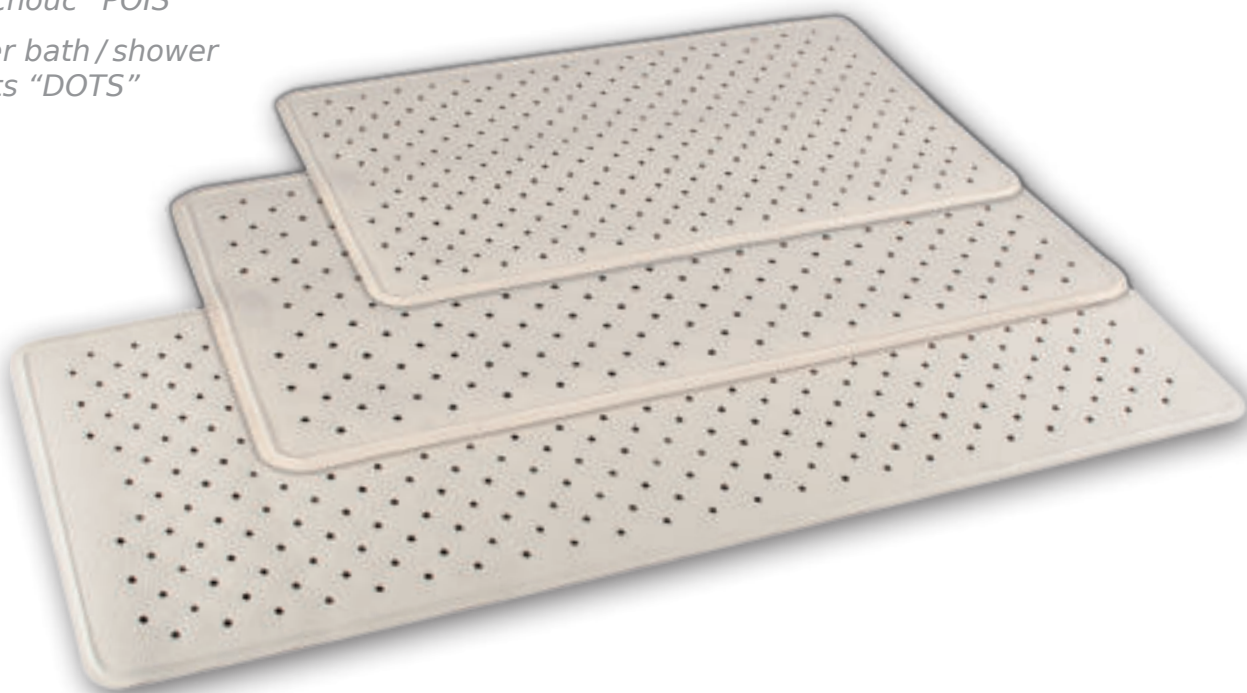

Ref.		Tamaño Cms.
<b>2005</b>	<b>Bañera / Bain / Bath</b>	<b>65 x 35</b>
<b>2006</b>	<b>Bañera / Bain / Bath</b>	<b>75 x 35</b>
<b>2007</b>	<b>Bañera / Bain / Bath</b>	<b>95 x 35</b>
<b>2008</b>	<b>Ducha / Douche / Shower</b>	<b>54 x 54</b>
<b>2009</b>	<b>Ducha / Douche / Shower</b>	<b>40 x 40</b>

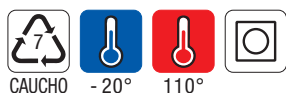

CAUCHO -20° 110°

## Orinal Cuña Clínica con asa

*Bassin de Lit  
Clinic Bedpan*

Ref.

**807**



## Orinal "Botella"

*Urinal Homme  
Male Bedpan*

Ref.

**808**

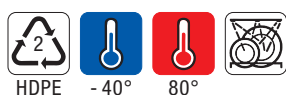

HDPE -40° 80°





 Pág. 55	 Pág. 55	 Pág. 55	 Pág. 56
 Pág. 56	 Pág. 56	 Pág. 56	 Pág. 57
 Pág. 57	 Pág. 57	 Pág. 58	 Pág. 58
 Pág. 58	 Pág. 59	 Pág. 59	 Pág. 59
 Pág. 60	 Pág. 60	 Pág. 61	 Pág. 61
 Pág. 62	 Pág. 62		



HORECA line

### Bandeja cambio "CLIP"

Porte-factures avec clip  
Exchange tray with clip



Ref.	Tamaño Cms.
<b>131</b>	<b>14 x 21 x 2</b>

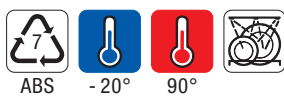

### Platillo Cambio "CLIP"

Porte-pourboire avec clip  
Exchange plate with clip



Ref.	Ø Cms.
<b>133</b>	<b>13</b>

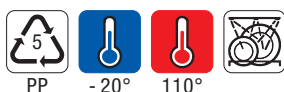

### Bandeja Cambio

Porte-factures  
Exchange tray



Ref.	Tamaño Cms.
<b>130</b>	<b>12 x 18 x 2</b>

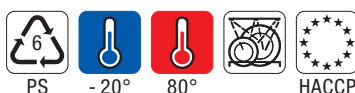

**Palillero rectangular**

Porte cure-dents rectg.  
Stick pot rectg.



Ref.	Tamaño Cms.
<b>301</b>	<b>6 x 2,5 x 7</b>



**Palillero "Flex"**

Porte cure-dents  
Stick pot



Ref.	Tamaño Cms.
<b>101</b>	<b>5 x 5 x 5,5</b>



**Salero Facetas**

Salière facette  
Salt pot facet



Ref.	Ø Cms.
<b>210</b>	<b>4,5 x 6</b>



**Cenicero Melamina**

Cendrier melamine  
Melamine ashtray

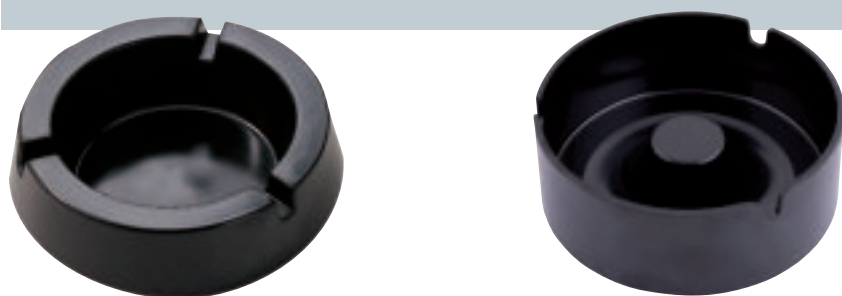

"LUCKY"

Ref.	Ø x Altura Cms.
<b>794</b>	<b>13 x 3,5</b>

"DUQUE"

Ref.	Ø x Altura Cms.
<b>796</b>	<b>10 x 4</b>



## Vitrina

Vitrine  
Showcase



Ref.	Tamaño Cms.
<b>1322</b>	<b>45 x 30 x 18</b>



## Vitrina Doble piso

Vitrine Double étage  
Showcase Double-decker



Ref.	Tamaño Cms.
<b>1323</b>	<b>46 x 30 x 40</b>

## Vitrina MINI Doble piso

Vitrine MINI Double étage  
Showcase MINI Double-decker



Ref.	Tamaño Cms.
<b>1321</b>	<b>32 x 19 x 30</b>





Cubertero GN 1/1

Range-couverts Gastro  
Cutlery GN

Ref.	Tamaño Cms.
<b>3086</b>	<b>53 x 32,5 x 9,5</b>



Tapa Cubertero GN 1/1

Couvercle Range-couverts  
Cutlery cover GN

Ref.	Tamaño Cms.
<b>3087</b>	<b>53 x 32,5 x 2</b>



Cesta Compra

Pannier a distribution  
Shopping basket



Ref.	Lts.	Cms.
<b>6045</b>	<b>22</b>	<b>43 x 32 x 24</b>

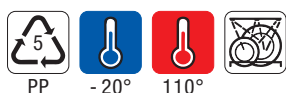

## Cubos Alimentación Graduados, asa inox

*Seaux alimentaire gradué, anse inox*

*Food buckets graduated, inox handle*



Ref.	Capacidad Lts.	Ø Cms.
<b>441</b>	<b>11</b>	<b>30 x 25</b>
<b>485</b>	<b>7</b>	<b>25 x 23</b>

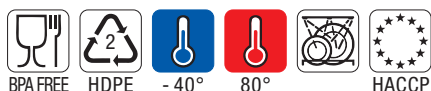

## Cubo Alimentación Graduado con vertedor, asa inox

*Seau alimentaire avec verseur gradué, anse inox*

*Food bucket with spill graduated, inox handle*



Ref.	Capacidad Lts.	Ø Cms.
<b>442</b>	<b>13</b>	<b>30 x 29</b>

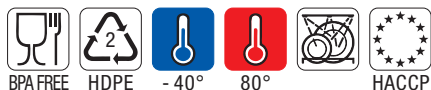

## Cubo Alimentación Graduado, asa inox + tapa

*Seau alimentaire gradué, anse inox avec couvercle*

*Food bucket graduated, inox handle with lid*



Ref.	Capacidad Lts.	Ø Cms.
<b>478</b>	<b>17</b>	<b>33 x 29</b>

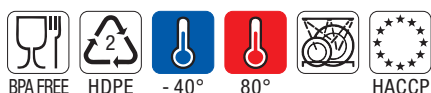

## Cajas norma Europa 60 x 40

Casse Euronorme  
Europallet Boxes

## Fondo y paredes cerradas

Fond et parois compacts  
All closed

Ref.	Tamaño exterior Cms.	Tamaño interior Cms.
<b>4407</b>	<b>60 x 40 x 7</b>	<b>56,5 x 36,5 x 6,5</b>
<b>4410</b>	<b>60 x 40 x 10</b>	<b>56,5 x 36,5 x 9,5</b>
<b>4413</b>	<b>60 x 40 x 13</b>	<b>56,5 x 36,5 x 12,5</b>

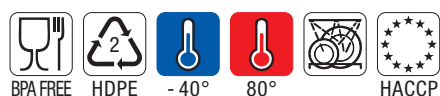

## Fondo y paredes de rejilla

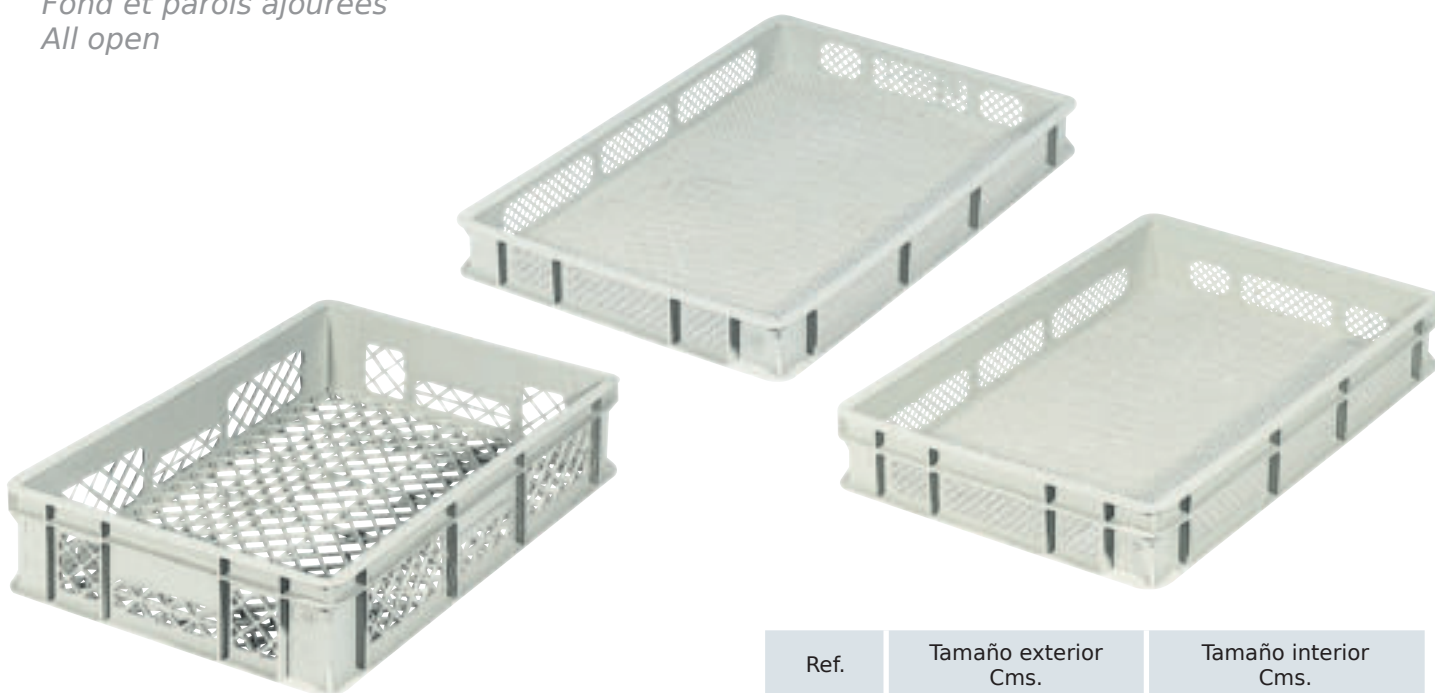
Fond et parois ajourées  
All open

Ref.	Tamaño exterior Cms.	Tamaño interior Cms.
<b>6007</b>	<b>60 x 40 x 7</b>	<b>56,5 x 36,5 x 6,5</b>
<b>6010</b>	<b>60 x 40 x 10</b>	<b>56,5 x 36,5 x 9,5</b>
<b>6013</b>	<b>60 x 40 x 13</b>	<b>56,5 x 36,5 x 12,5</b>

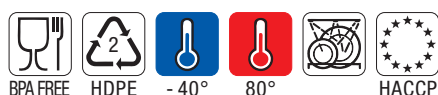

**Tapa norma Europa**

*Couvercle  
Lid*



Ref.	Tamaño Cms.
<b>4400</b>	<b>60 x 40 x 2</b>

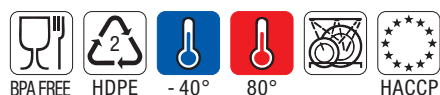

**Carro 60 x 40**

*Chariot  
Trolley*



Ref.	Tamaño Cms.	Peso Kgs.
<b>5800</b>	<b>62 x 42 x 16</b>	<b>250</b>

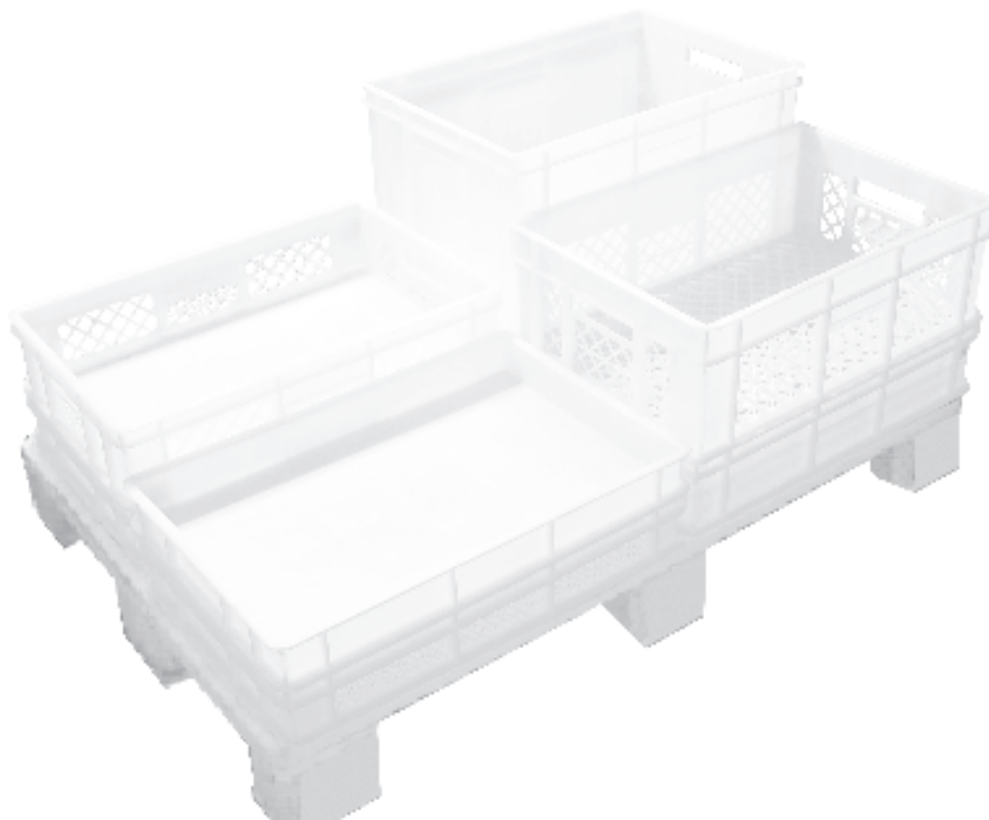



**Tapa Barreño.**

Para barreños 30, 40 y 50 L. Refs. 652, 719, 699

*Couvercle baquet.*

*Pour baquets 30, 40 et 50 L. Réf. 652, 719, 699*

*Food tub lid.*

*For tubs 30, 40 and 50 L. Ref. 652, 719, 699*



Ref.	Ø Cms.
<b>670</b>	<b>49 x 5</b>

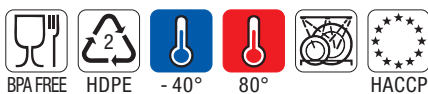

**Barreños Alimentación**

*Baquets ronds aliments*

*Food tubs*



Ref.	Capacidad Lts.	Ø x Altura Cms.
<b>3305</b>	<b>75</b>	<b>49 x 58</b>
<b>3306</b>	<b>75 + Tapa</b>	<b>50 x 60</b>
<b>3310</b>	<b>100</b>	<b>52 x 67</b>
<b>3311</b>	<b>100 + Tapa</b>	<b>54 x 69</b>

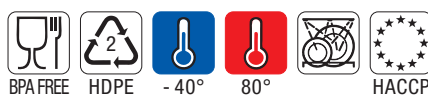



Apto para uso alimentario. Libre de Bisphenol A  
 Conformes au contact alimentaire. Sans Bisphenol A  
 Suitable for food contact. Bisphenol A Free



Apto para uso alimentario  
 Conformes au contact alimentaire  
 Suitable for food contact



Apto para lavavajillas  
 Apte pour lave vaisselle  
 Suitable for dishwasher



Cumple Norma HACCP  
 Déclaration de conformité HACCP  
 HACCP Compliance Statement



Tipo de material  
 Type de matériaux  
 Material type



Temperatura mínima  
 Température minimale  
 Minimum temperature



Temperatura máxima  
 Température maximale  
 Maximum temperature



Apto para microondas  
 Apte pour micro-ondes  
 Suitable for microwave



NO apto para microondas  
 Ne pas utiliser au micro-ondes  
 Not suitable for microwave



Apto para lavadora  
 Apte pour lave linge  
 Suitable for washing machine

Identificación y propiedades de los distintos tipos de materiales

*Identification et propriétés des différents types de matériaux*  
*Identification and properties of different kinds of materials*



MATERIAL  
 Matériel  
 Material



PROPIEDADES  
 Propriétés  
 Properties

<b>2</b>	<b>HDPE</b> Polietileno Alta Densidad	- 40°	+80°	Rigidez baja, Muy alta resistencia a los impactos. Resistente a los ácidos, disolventes, aceites y gasolina. <i>Faible rigidité, la résistance aux chocs très élevée. Résistant aux acides, solvants, huiles et l'essence. Low stiffness, very high impact resistance. Resistant to acids, solvents, oils and gasoline.</i>
<b>3</b>	<b>PVC</b> Policloruro de Vinilo	- 40°	+80°	Resistente y flexible en función de sus diferentes durezas. <i>Robuste et souple en fonction de leurs différentes duretés. Tough and flexible depending on their different hardnesses.</i>
<b>4</b>	<b>LDPE</b> Polietileno Baja Densidad	- 40°	+80°	Flexible. Muy alta resistencia a los impactos. Resistente a los ácidos, disolventes, aceites y gasolina. <i>Souple. Très bonne résistance à l'impact. Résistant aux acides, solvants, huiles et l'essence. Flexible. Very high impact resistance. Resistant to acids, solvents, oils and gasoline.</i>
<b>5</b>	<b>PP</b> Polipropileno	- 20°	+110°	Buena rigidez. Resistencia alta a los impactos. Resistente a los ácidos, disolventes, aceites y gasolina. <i>Bonne rigidité. Haute résistance à l'impact. Résistant aux acides, solvants, huiles et l'essence. Good rigidity. High impact resistance. Resistant to acids, solvents, oils and gasoline.</i>
<b>6</b>	<b>PS</b> Poliestireno	- 20°	+80°	Alta rigidez. Poca resistencia a los impactos. Resistente a grasas. <i>Très grande rigidité. Résistance aux chocs légère. Résistant aux graisses. High rigidity. Slight impact resistance. Resistant to fats.</i>
<b>7</b>	<b>SAN</b> Estireno Acrilo Nitrilo	- 20°	+90°	Alta rigidez. Resistencia baja a los impactos. Resistente a los ácidos orgánicos, grasas animales y vegetales. <i>Très grande rigidité. Faible résistance à l'impact. Résistant aux acides organiques, graisses animales et végétales. High rigidity. Low impact resistance. Resistant to organic acids, animal and vegetable fats.</i>
<b>7</b>	<b>ABS</b> Acrilo Butadieno Estireno	- 20°	+90°	Rígido. Resistencia alta a los impactos. Resistente a grasas. <i>Rigide. Haute résistance à l'impact. Résistant aux graisses. Rigid. High impact resistance. Resistant to fats.</i>
<b>7</b>	<b>PA</b> Poliamida	- 20°	+110°	Resistencia mecánica y flexible. Alta resistencia a los impactos. Resistente a grasas. <i>Résistance mécanique et de flexibilité. Haute résistance à l'impact. Résistant aux graisses. Mechanical strength and flexibility. High impact resistance. Resistant to fats.</i>
<b>7</b>	<b>PBT</b> Tereftalato de polibutileno	- 40°	+220°	Resistencia mecánica y muy rígido. Alta resistencia a los impactos. Resistente a grasas y aceites. <i>Résistance mécanique et très rigide. Haute résistance à l'impact. Résistant aux graisses et aux huiles. Mechanical resistance and very rigid. High impact resistance. Resistant to fats and oils.</i>
<b>7</b>	<b>PC</b> Policarbonato	- 40°	+150°	Resistencia mecánica y flexible. Muy alta resistencia a los impactos. Resistente a grasas. <i>Résistance mécanique et souple. Très bonne résistance à l'impact. Résistant aux graisses. Mechanical strength and flexibility. Very high impact resistance. Resistant to fats.</i>
<b>7</b>	<b>CAUCHO</b>	- 20°	+110°	Resistente y muy flexible. Resistencia a los impactos. Resistente a grasas. <i>Résistant et très souple. Résistance aux chocs. Résistant aux graisses. Resistant and very flexible. Impact resistance. Resistant to fats.</i>
<b>7</b>	<b>MELAMINA</b>	- 20°	+110°	Muy alta rigidez. Resistencia media a los impactos. Resistente a los ácidos orgánicos, grasas animales y vegetales. No microondas. <i>Très grande rigidité. Résistance moyenne aux chocs. Résistant aux acides organiques, graisses animales et végétales. Pas de micro-ondes. Very high stiffness. Average resistance to impacts. Resistant to organic acids, animal and vegetable fats. No microwave.</i>
<b>7</b>	<b>TRITAN</b>	- 35°	+100°	Resistencia mecánica y rígido. Buena resistencia a los impactos. Resistente a grasas y aceites. <i>Résistance mécanique et rigide. Bonne résistance à l'impact. Résistant aux graisses et aux huiles. Mechanical resistance and rigid. Good impact resistance. Resistant to fats and oils.</i>

www.fervik.com



Transformación del plástico desde 1955

*Transformation du plastique depuis 1955*  
*Plastic Manufacturers since 1955*



**FERVIK, S.A**

Ctra. Sabadell - Granollers, Km. 7,1  
08184 Palau-solità i Plegamans · Barcelona · Spain  
Tel. 93 864 87 56 · Fax 93 864 86 70  
e-mail: [fervik@fervik.com](mailto:fervik@fervik.com)



Nº RGS. 39-03319/B HACCP